

COMUNE DI TRECCHINA

(Provincia di Potenza)

OGGETTO:

PO FESR BASILICATA 2014-2020 Asse 8. Azione 10.10.7.1.
Interventi finalizzati alla riqualificazione dell'edificio scolastico
scuola dell'infanzia e primaria, sita in Trecchina P.zza del Popolo.

FASE ESECUTIVA

ELABORATO N.: 14

- PARTICOLARE ASCENSORE

TRECCHINA, Sett. 2019

IL TECNICO

Ing. Luigi Pasoluzzi

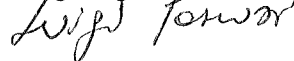

IL RUP

(Geom. Nicola CRESCI)

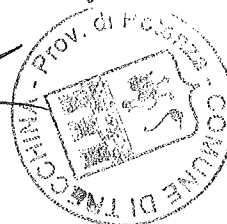
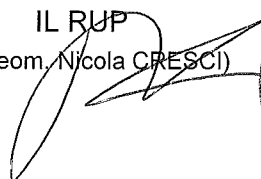

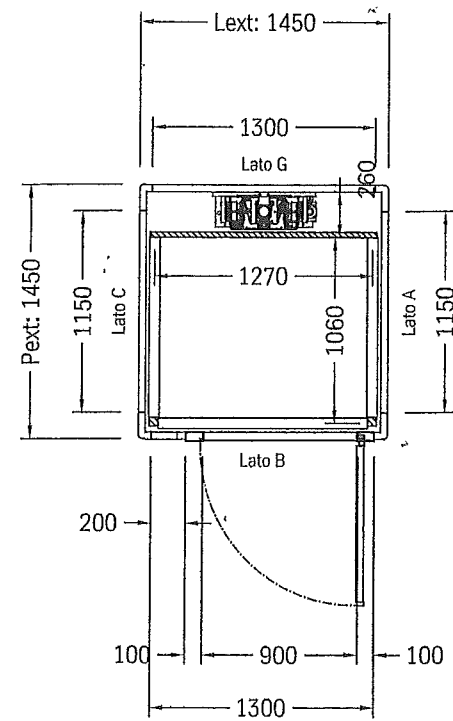

Piano 0
 Lato B
 Piano 0-DX
 Spia 900x2000
 Montanti 100/100

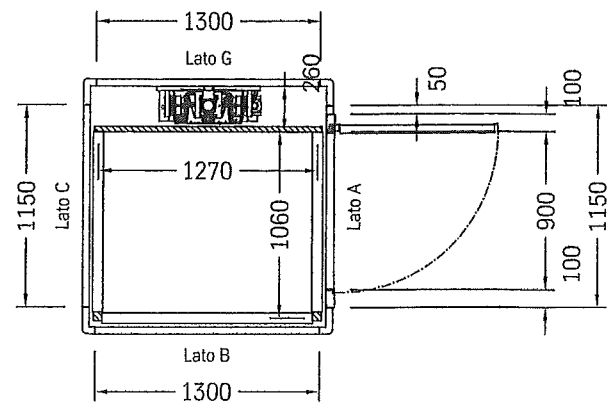

Piano 1
 Lato A
 Piano 1-DX
 Spia 900x2000
 Montanti 100/100

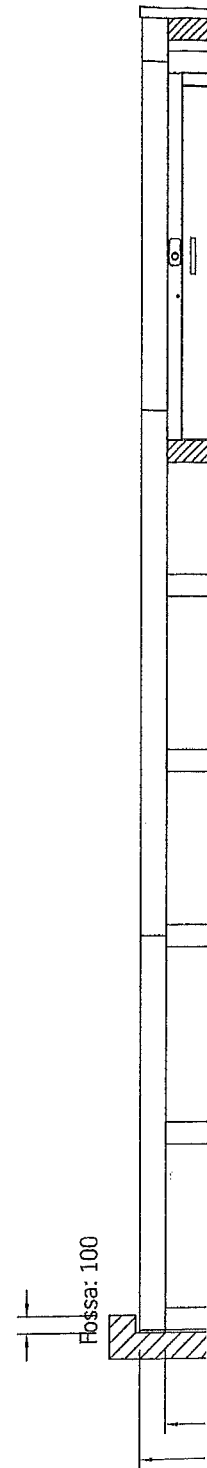
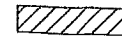
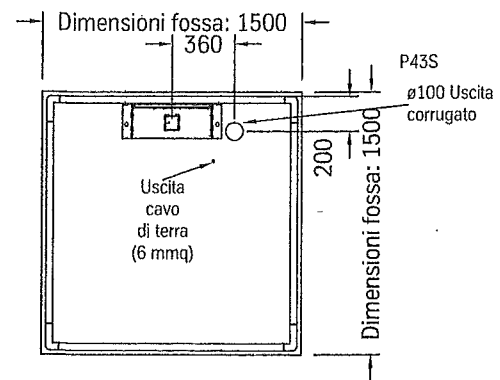



Piano 0

Lato B
Piano 0-DX
Spia 900x2000
Montanti 100/100

100

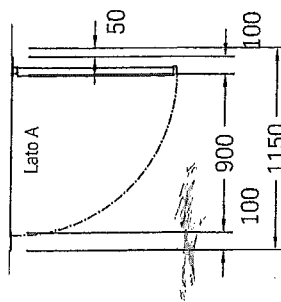

Piano 1

Lato A
Piano 1-DX
Spia 900x2000
Montanti 100/100

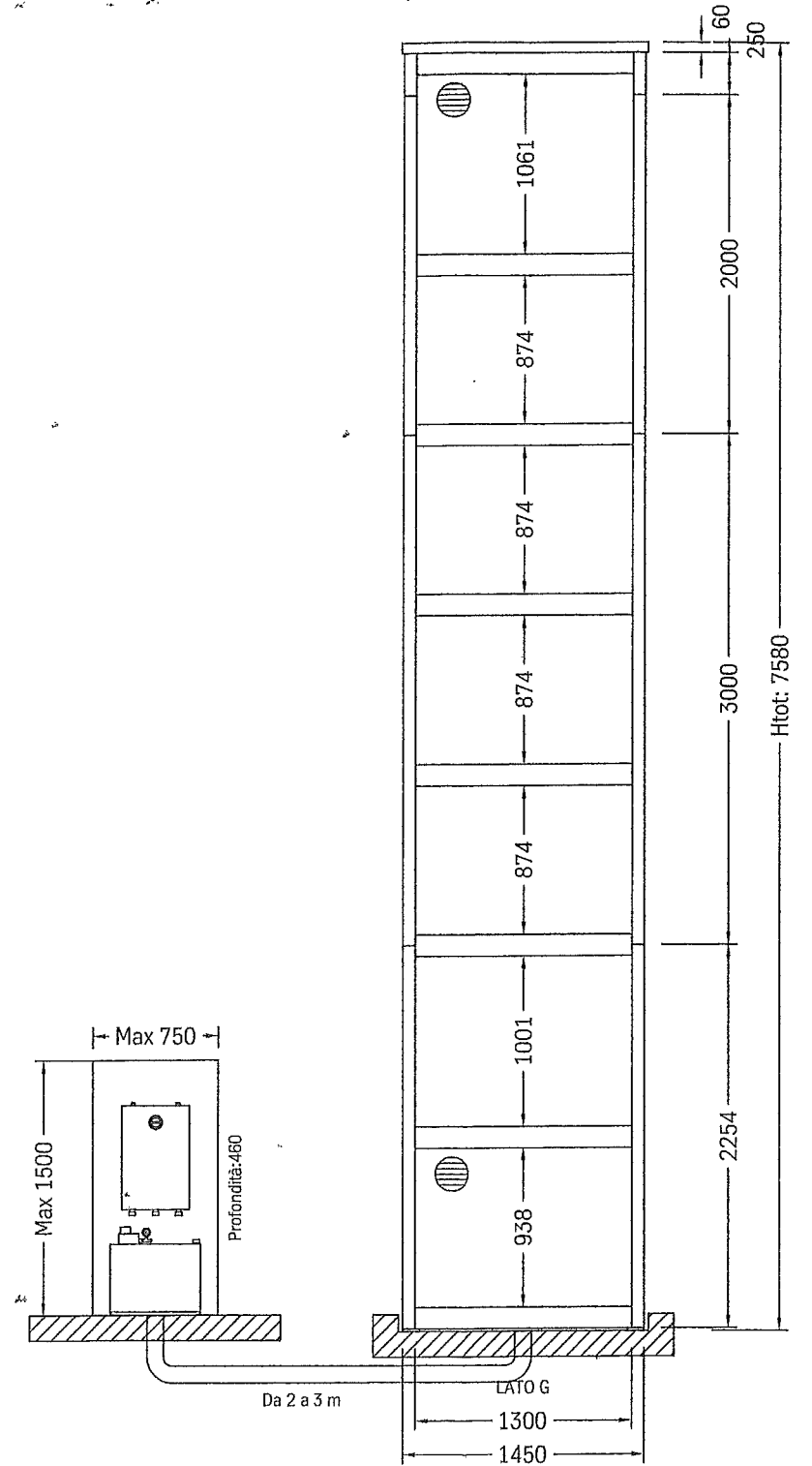
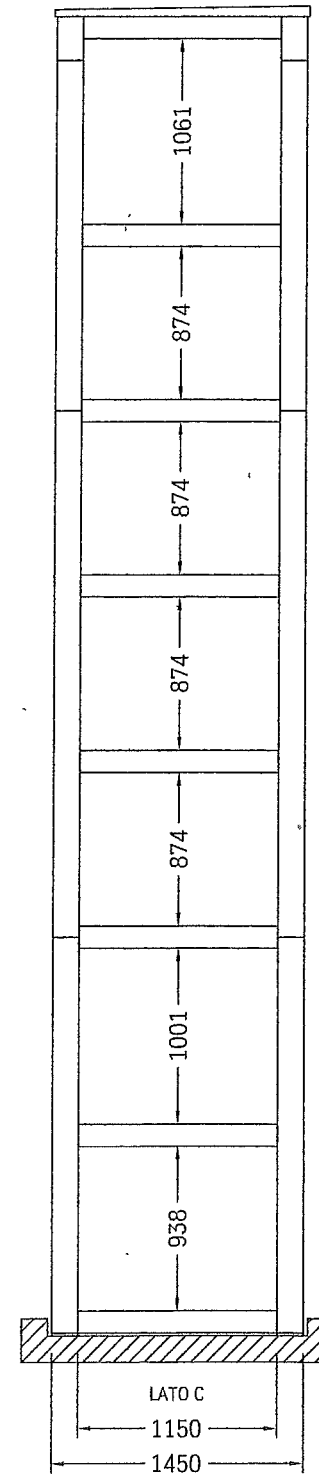
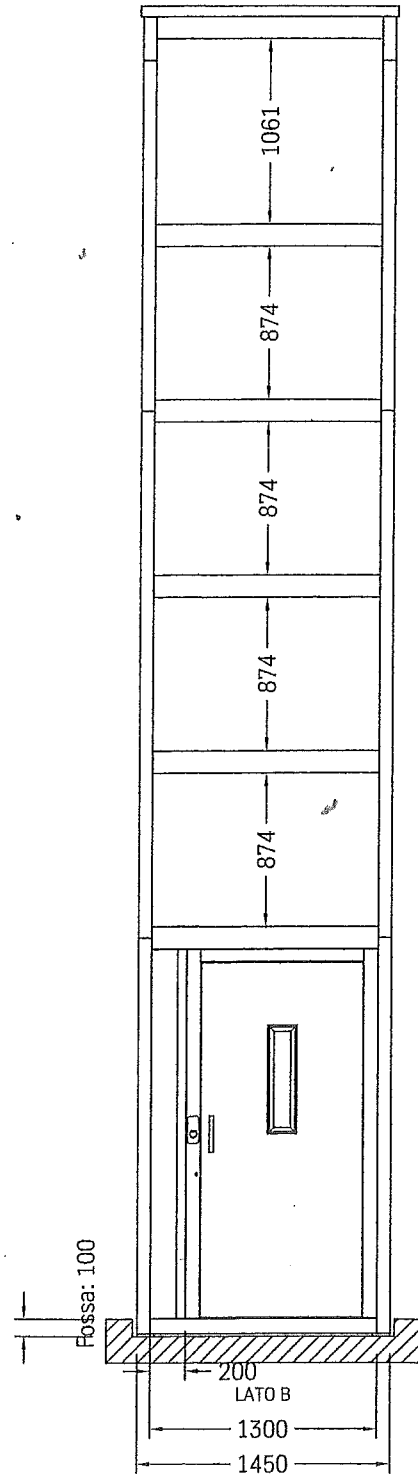
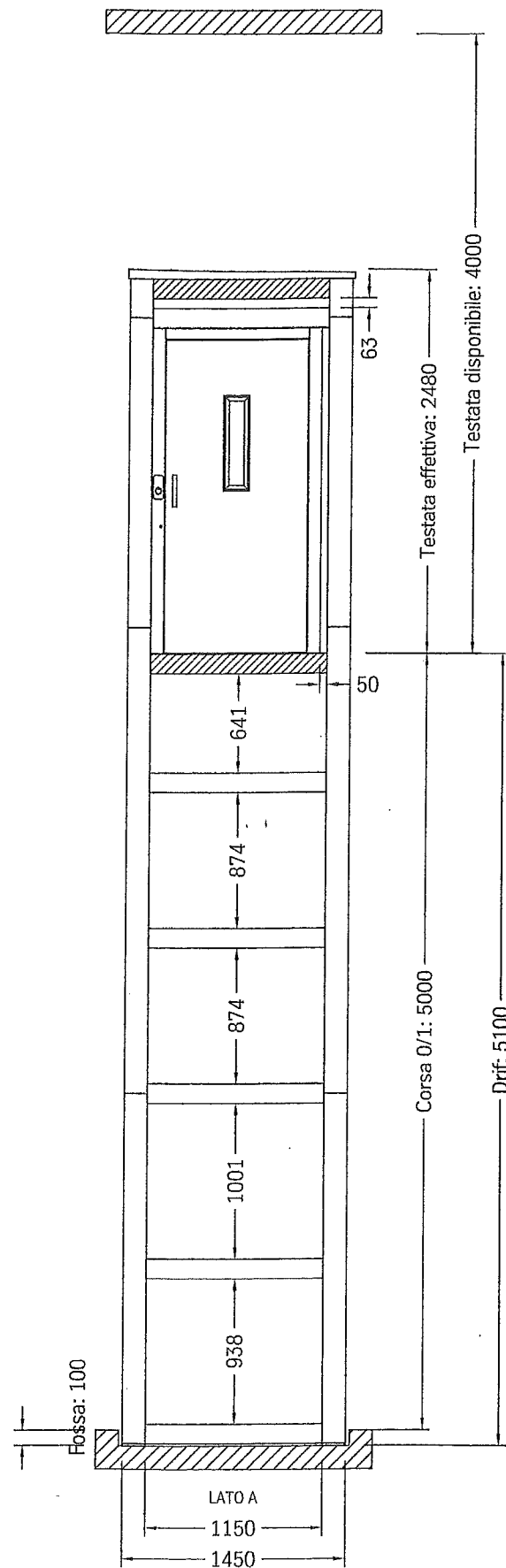
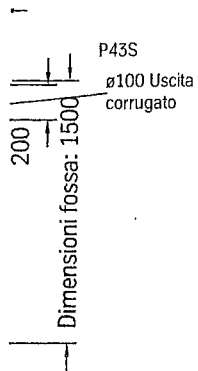

N.B.: Peso complessivo del castello, escluso tamponamenti in vetro o altro: 625 Kg